

PSTricks

pst-magneticfield

Magnetic field lines of a solenoid; v.1.17

July 6, 2022

Package author(s):
Juergen Gilg († 2022)
Manuel Luque
Herbert Voß

The package `pst-magneticfield` aims to trace the shape of field lines of a solenoid. The physical parameters are the radius of the solenoid, the number of turns and its length, the default values are given below:

1. the number of turns: $N=6$;
2. the radius : $R=2$;
3. the length : $L=4$.

The field lines were calculated with the Runge-Kutta 2 algorithm, which, after several tries, seemed to be the best compromise between speed and accuracy of calculations for the path. The calculation of elliptic integrals for the evaluation of the magnetic field was achieved by polynomial approximations from the "Handbook of Mathematical Functions With Formulas, Graph, And Mathematical Tables" by Milton Abramowitz and Irene. A. Stegun (<http://www.math.sfu.ca/~cbm/aands/>). [1]

Contents

1 Introduction	4
2 Influence of physical parameters on the map magnetic field	5
2.1 The length of the solenoid	5
2.2 The number of turns	6
3 The three route options	8
3.1 The number of field lines	8
3.2 The number of points for the path	9
4 The parameter numSpires	10
5 The parameter AntiHelmholtz	12
6 3D views	13
7 Density plots	15
8 Stream density	17
9 Bar magnet	18
10 List of all optional arguments for pst-magneticfield	23
References	23

1 Introduction

The route options, with the default values are as follows:

1. The maximum number of points on each line of the entire coil: `pointsB=500`;
2. the maximum number of points on lines around turns selected: `pointsS=1000`;
3. the number of lines of the entire coil: `nL=8`;
4. differential steps for the lines of the entire coil: `PasB=0.02`;
5. differential steps for the lines around turns selected: `PasS=0.00275`;
6. the choice of individual coils to improve the rendering of its layout: `numSpires={}`, we place following the sign "=" the numbers of turns 1 2 3 etc. starting from the top spire. By default, all the turns are targeted.
7. The number of field lines around the turns selected: `nS=1`.
8. We may decide not to represent the solenoid with the option `drawSelf=false` is useful for 3D representation.
9. The route options for the turns (color, thickness, arrows) are:
 - a) The color and thickness of the coils: `styleSpire=styleSpire` ;
 - b) the current direction signs: `styleCourant=sensCourant` .

```
\newpsstyle{styleSpire}{linecap=1,linecolor=red,linewidth=2\pslinewidth}
\newpsstyle{sensCourant}{linecolor=red,linewidth=2\pslinewidth,arrowinset=0.1}
```

10. The color and thickness of the field lines can be adjusted with the usual `pstricks` parameters: `linecolor` and `linewidth`

A command `\psmagneticfieldThreeD` allows 3D visualization of the solenoid and field lines.

<code>\psmagneticfield</code>	<code>[Options]</code>	<code>(x₁, y₁)</code>	<code>(x₂, y₂)</code>
<code>\psmagneticfieldThreeD</code>	<code>[Options]</code>	<code>(x₁, y₁)</code>	<code>(x₂, y₂)</code>

Missing coordinates are substituted to `(-6, -5)` `(6, 5)`!

2 Influence of physical parameters on the map magnetic field

2.1 The length of the solenoid

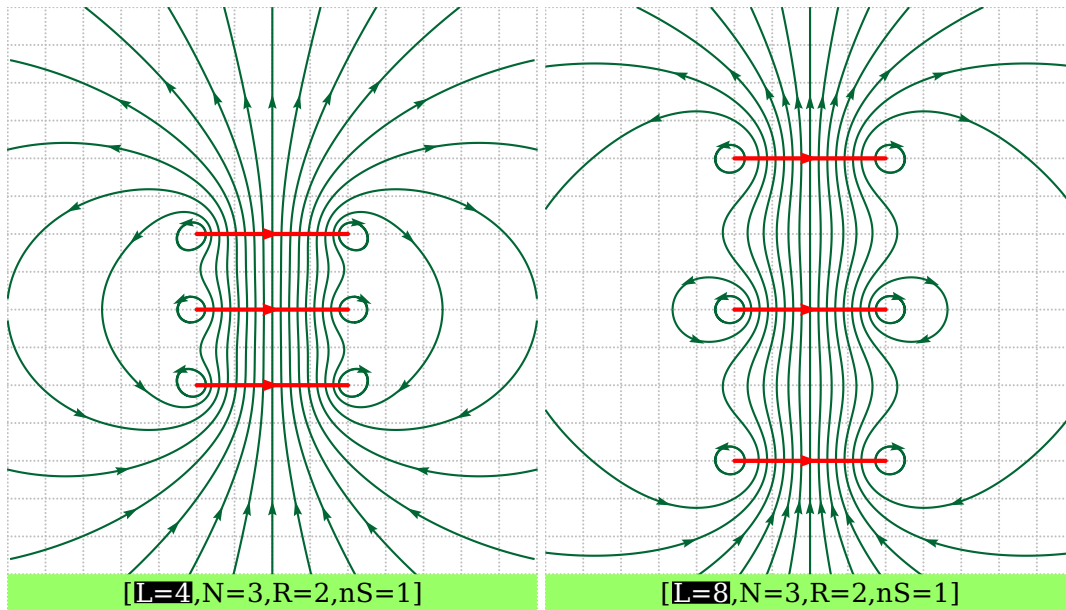

```

\psset{unit=0.5cm}
\begin{pspicture*}[showgrid](-7,-8)(7,8)
\psmagneticfield[linecolor={HTML}{006633}],N=3,R=2,nS=1](-7,-8)(7,8)
\psframe*[linecolor={HTML}{99FF66}](-7,-8)(7,-7)
\rput(0,-7.5){[\Cadre{\textcolor{white}{L=4}},N=3,R=2,nS=1]}
\end{pspicture*}
\begin{pspicture*}[showgrid](-7,-8)(7,8)
\psmagneticfield[linecolor={HTML}{006633}],L=8,N=3,R=2,nS=1,PasB=0.0025,pointsB
=5500](-7,-8)(7,8)
\psframe*[linecolor={HTML}{99FF66}](-7,-8)(7,-7)
\rput(0,-7.5){[\Cadre{\textcolor{white}{L=8}},N=3,R=2,nS=1]}
\end{pspicture*}

```

Note: To refine the layout of the second solenoid, we had to increase the points and lower the pitch of the route: `pointsB=5500,PasB=0.0025`, which takes more time for the calculations.

2.2 The number of turns

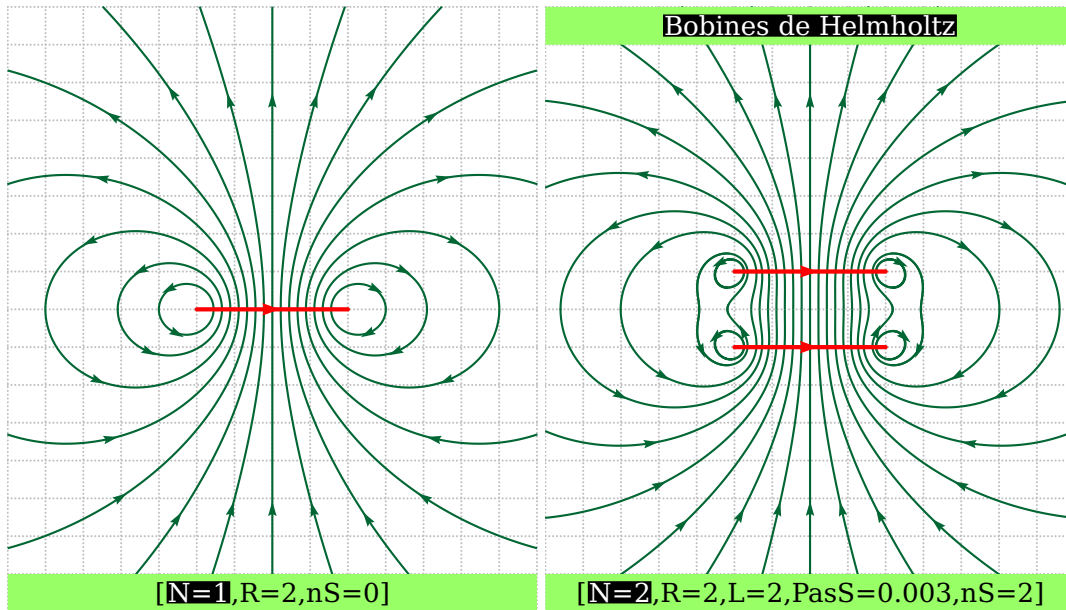

```

\psset{unit=0.5}
\begin{pspicture*}[showgrid](-7,-8)(7,8)
\psmagneticfield[linecolor={[HTML]{006633}}, N=1, R=2, nS=0](-7,-8)(7,8)
\psframe*[linecolor={[HTML]{99FF66}}](-7,-8)(7,-7)
\rput(0,-7.5){[\Cadre{\textcolor{white}{N=1}}, R=2, nS=0]}
\end{pspicture*}
\begin{pspicture*}[showgrid](-7,-8)(7,8)
\psmagneticfield[linecolor={[HTML]{006633}}, N=2, R=2, L=2, PasS=0.003, nS=2](-7,-8)
(7,8)
\psframe*[linecolor={[HTML]{99FF66}}](-7,7)(7,8)
\rput(0,7.5){[\Cadre{\textcolor{white}{Bobines de Helmholtz}}]}
\psframe*[linecolor={[HTML]{99FF66}}](-7,-8)(7,-7)
\rput(0,-7.5){[\Cadre{\textcolor{white}{N=2}}, R=2, L=2, PasS=0.003, nS=2]}
\end{pspicture*}

```

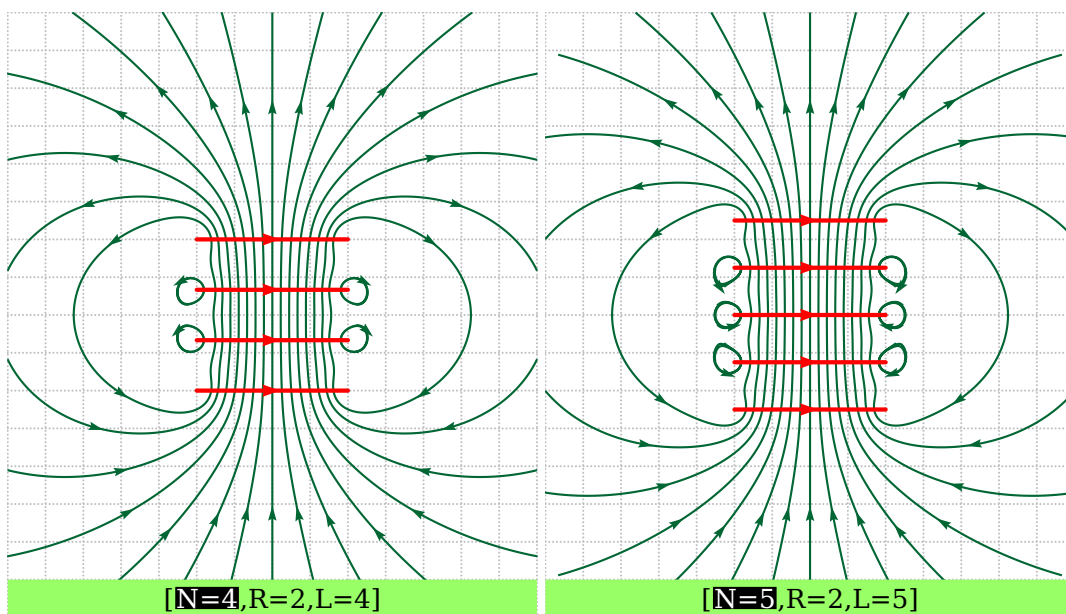

```
\psset{unit=0.5}
\begin{pspicture*}[showgrid](-7,-8)(7,8)
\psmagneticfield[linecolor={HTML}{006633}],N=4,R=2,numSpires=2 3(-7,-8)(7,8)
\psframe*[linecolor={HTML}{99FF66}](-7,-8)(7,-7)
\rput(0,-7.5){[\Cadre{\textcolor{white}{N=4}},R=2,L=4]}
\end{pspicture*}
\begin{pspicture*}[showgrid](-7,-8)(7,8)
\psmagneticfield[linecolor={HTML}{006633}],N=5,R=2,L=5,PasS=0.004,numSpires=2 3
4(-7,-8)(7,8)
\psframe*[linecolor={HTML}{99FF66}](-7,-8)(7,-7)
\rput(0,-7.5){[\Cadre{\textcolor{white}{N=5}},R=2,L=5]}
\end{pspicture*}
```

3 The three route options

3.1 The number of field lines

Due to the symmetry of the problem the number of field lines given (nL) option is half the number actually represented with an added line identic to the the axis of revolution. We must also add the lines around the turns nS, these turns can be selected individually numSpires.

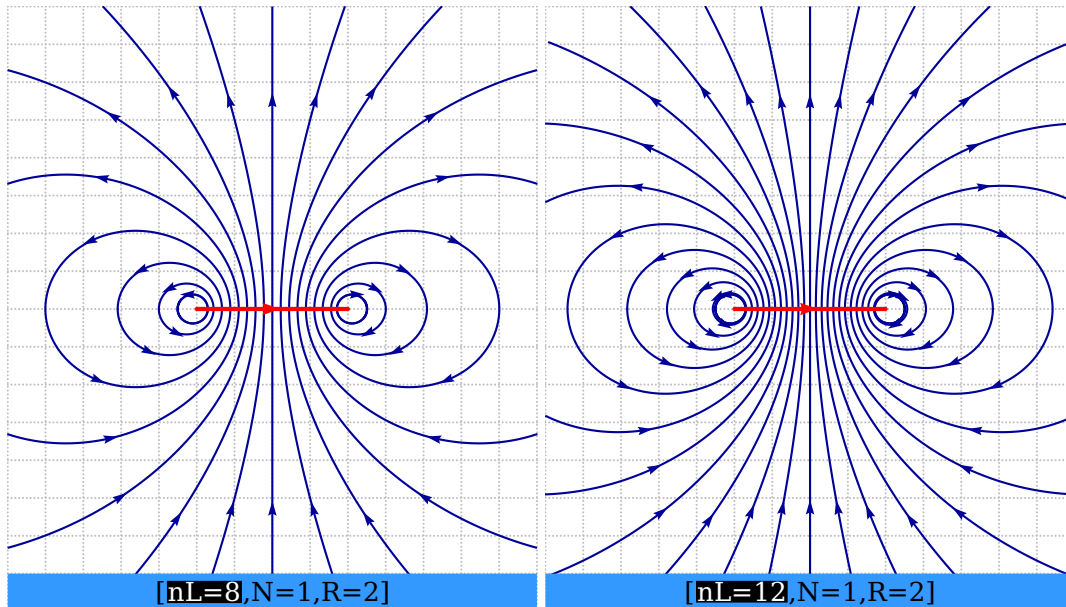

```

\psset{unit=0.5}
\begin{pspicture*}[showgrid](-7,-8)(7,8)
\psmagneticfield[linecolor={HTML}{000099}],N=1,R=2](-7,-8)(7,8)
\psframe*[linecolor={HTML}{3399FF}](-7,-8)(7,-7)
\rput(0,-7.5){[\Cadre{\textcolor{white}{nL=8}},N=1,R=2]}
\end{pspicture*}
\begin{pspicture*}[showgrid](-7,-8)(7,8)
\psmagneticfield[linecolor={HTML}{000099}],N=1,R=2,nL=12](-7,-8)(7,8)
\psframe*[linecolor={HTML}{3399FF}](-7,-8)(7,-7)
\rput(0,-7.5){[\Cadre{\textcolor{white}{nL=12}},N=1,R=2]}
\end{pspicture*}

```

3.2 The number of points for the path

The plot of field lines is achieved by a numerical method (RK2) and follows the step of the route and the number of selected points affect the accuracy of the route, as in the two examples below:

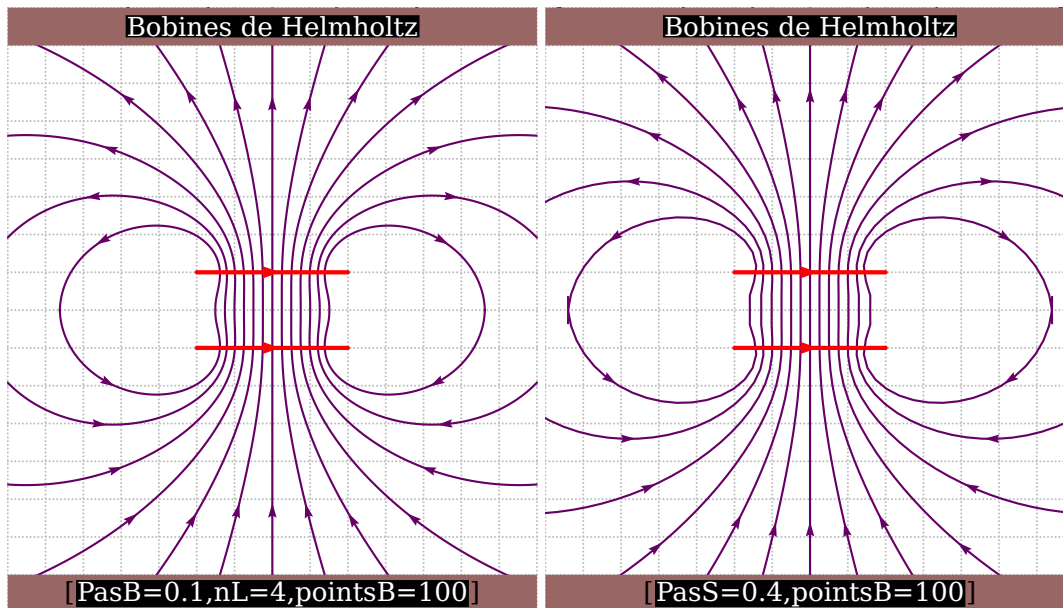

```

\psset{unit=0.5}
\begin{pspicture*}[showgrid](-7,-8)(7,8)
\psmagneticfield[linecolor={HTML}{660066}],N=2,R=2,L=2,PasB=0.1,nS=0,nL=7,pointsB=100](-7,-8)(7,8)
\psframe*[linecolor={HTML}{996666}](-7,7)(7,8)
\rput(0,7.5){\Cadre{\textcolor{white}{Bobines de Helmholtz}}}
\psframe*[linecolor={HTML}{996666}](-7,-8)(7,-7)
\rput(0,-7.5){[\Cadre{\textcolor{white}{PasB=0.1,nL=4,pointsB=100}}]}
\end{pspicture*}
\begin{pspicture*}[showgrid](-7,-8)(7,8)
\psmagneticfield[linecolor={HTML}{660066}],N=2,R=2,L=2,PasS=0.4,nS=0,nL=7,pointsB=100](-7,-8)(7,8)
\psframe*[linecolor={HTML}{996666}](-7,7)(7,8)
\rput(0,7.5){\Cadre{\textcolor{white}{Bobines de Helmholtz}}}
\psframe*[linecolor={HTML}{996666}](-7,-8)(7,-7)
\rput(0,-7.5){[\Cadre{\textcolor{white}{PasS=0.4,pointsB=100}}]}
\end{pspicture*}

```

If the defaults do not suit it must be found by testing the values that give a correct path.

4 The parameter numSpires

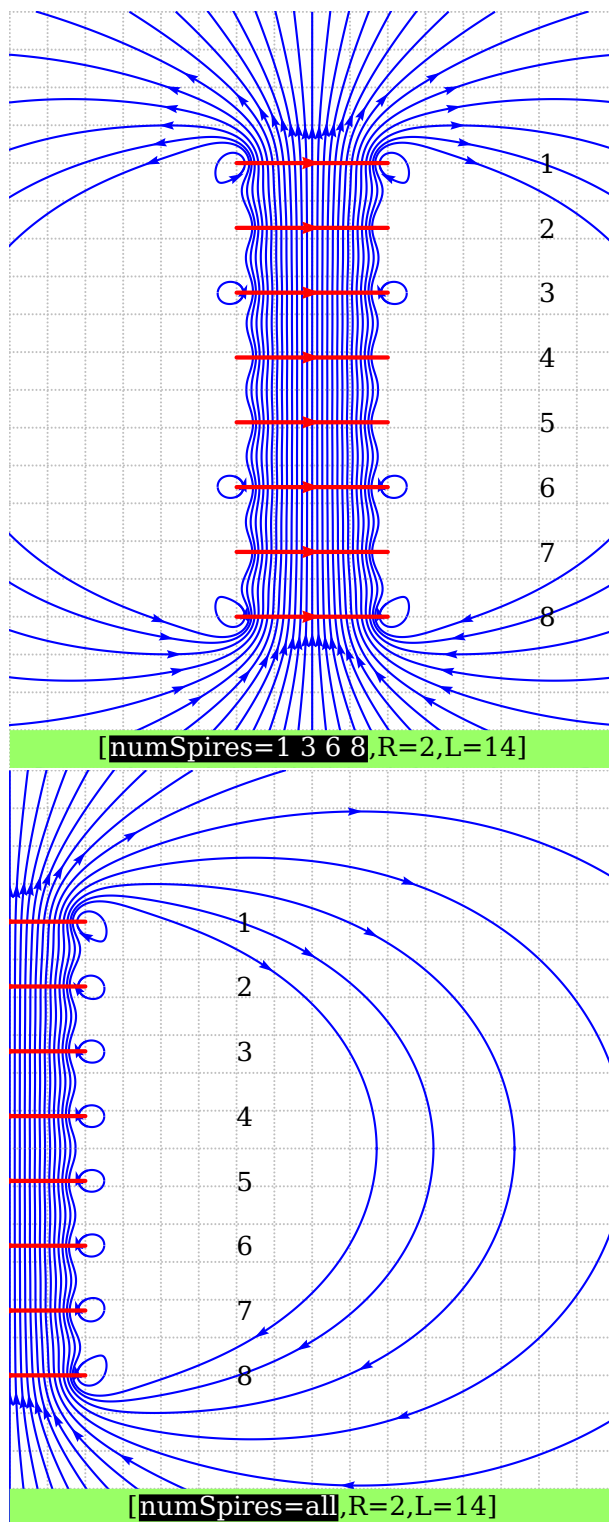

```

\psset{unit=0.5}
\begin{pspicture*}[showgrid](-8,-10)(8,10)
\psset{linecolor=blue}
\psmagneticfield[R=2,L=12,N=8,pointsS=500,nL=14,nS=1,numSpires=1 3 6 8,PasB
=0.075](-8,-10)(8,10)
\psframe*[linecolor={HTML}{99FF66}](-8,-10)(8,-9)

```

```
\rput(0,-9.5){[\Cadre{\textcolor{white}{numSpires=1 3 6 8}},R=2,L=14]}
\multido{\i=0+1}{8}{\rput[l](!6 6 12 7 div \i\space mul sub){\the\multidocount}}
\end{pspicture*}\quad
\begin{pspicture*}[showgrid](0,-10)(16,10)
\psset{linecolor=blue}
\psmagneticfield[R=2,L=12,N=8,pointsS=500,nL=14,numSpires=,nS=1,PasB=0.075](0,-10)
(16,10)
\psframe*[linecolor={HTML}{99FF66}](0,-10)(16,-9)
\rput(8,-9.5){[\Cadre{\textcolor{white}{numSpires=all}},R=2,L=14]}
\multido{\i=0+1}{8}{\rput[l](!6 6 12 7 div \i\space mul sub){\the\multidocount}}
\end{pspicture*}
```

5 The parameter AntiHelmholtz

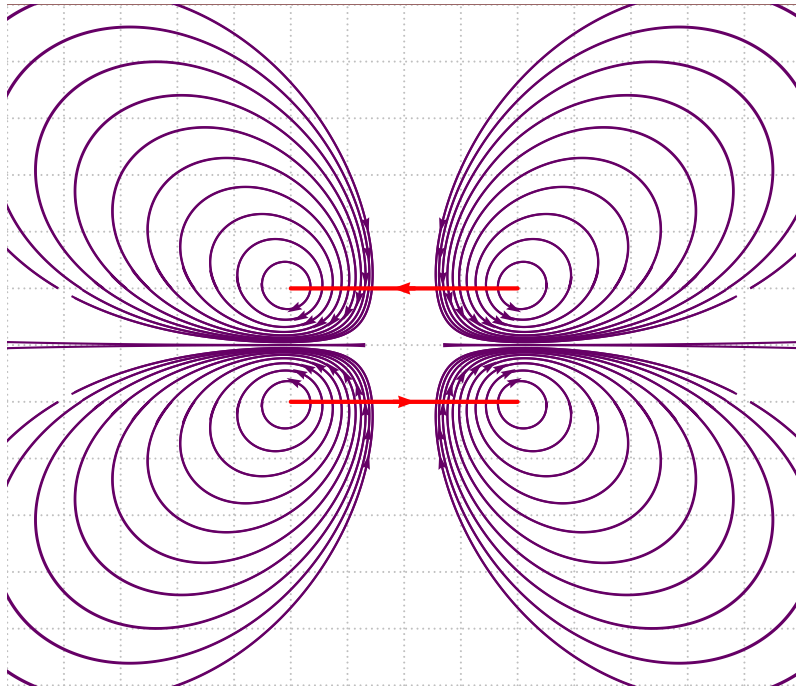

```

\psset{unit=0.75,AntiHelmholtz,N=2,
  R=2,pointsB=500,pointsS=1000,PasB=0.02,PasS=0.00275,nS=10,
  nL=2,drawSelf=true,styleSpire=styleSpire,styleCourant=sensCourant}
\newpsstyle{grille}{subgriddiv=0,gridcolor=blue!50,griddots=10}
\newpsstyle{cadre}{linecolor=yellow!50}
\begin{pspicture*}[showgrid](-7,-6)(7,6)
\psframe*[linecolor={HTML}{996666}](-7,6)(7,6)
\psmagneticfield[linecolor={HTML}{660066}]
\end{pspicture*}

```

6 3D views

3D views are possible with the macros

```
\psmagneticfield [Options] (x1,y1)(x2,y2)
\psmagneticfieldThreeD [Options] (x1,y1)(x2,y2)
```

in which options are settings `\psmagneticfield` and $(x1,y1)(x2,y2)$ coordinates of bottom left corner and upper right framework is encapsulated as the field map for `\psframe`. We can use the option `viewpoint` of the `pst-3d` package to change the view. The options framework are by default, the following:

```
\newsstyle{grille}{subgriddiv=0,gridcolor=lightgray,griddots=10}
\newsstyle{cadre}{linecolor=green!20}
```

In the following example we can see the handling of these two `psstyles`.

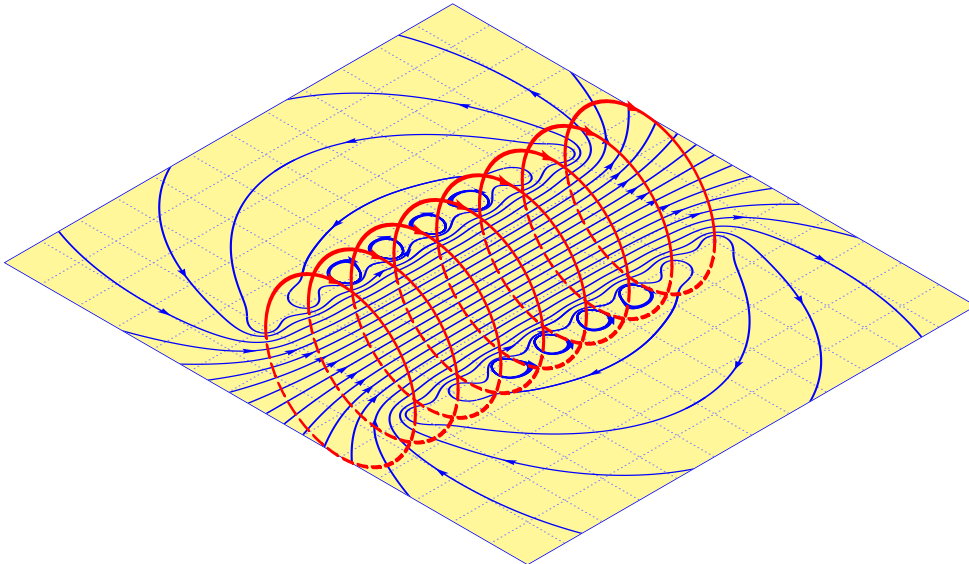

```
\psset{unit=0.7cm}
\newsstyle{grille}{subgriddiv=0,gridcolor=blue!50,griddots=10}
\newsstyle{cadre}{linecolor=yellow!50}
\begin{pspicture}(-7,-6)(7,6)
\psmagneticfieldThreeD[N=8,R=2,L=8,pointsB=1200,linecolor=blue,pointsS
=2000](-7,-6)(7,6)
\end{pspicture}
```

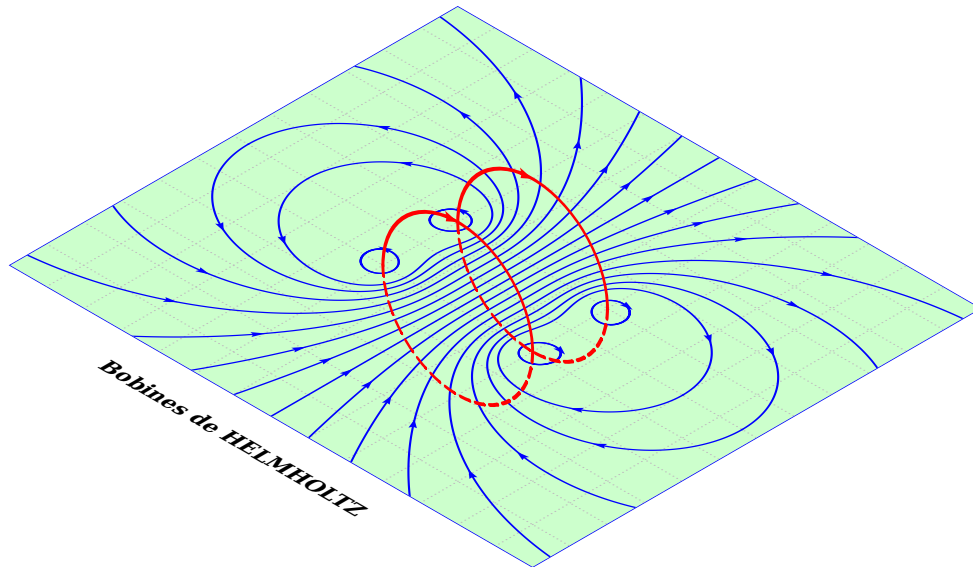

```
\psset{unit=0.7cm}
\begin{pspicture}(-7,-6)(7,6)
\psmagneticfieldThreeD[N=2,R=2,L=2,linecolor=blue](-7,-6)(7,6)
\ThreeDput{\rput(0,-7){\textbf{Bobines de HELMHOLTZ}}}
\end{pspicture}
```

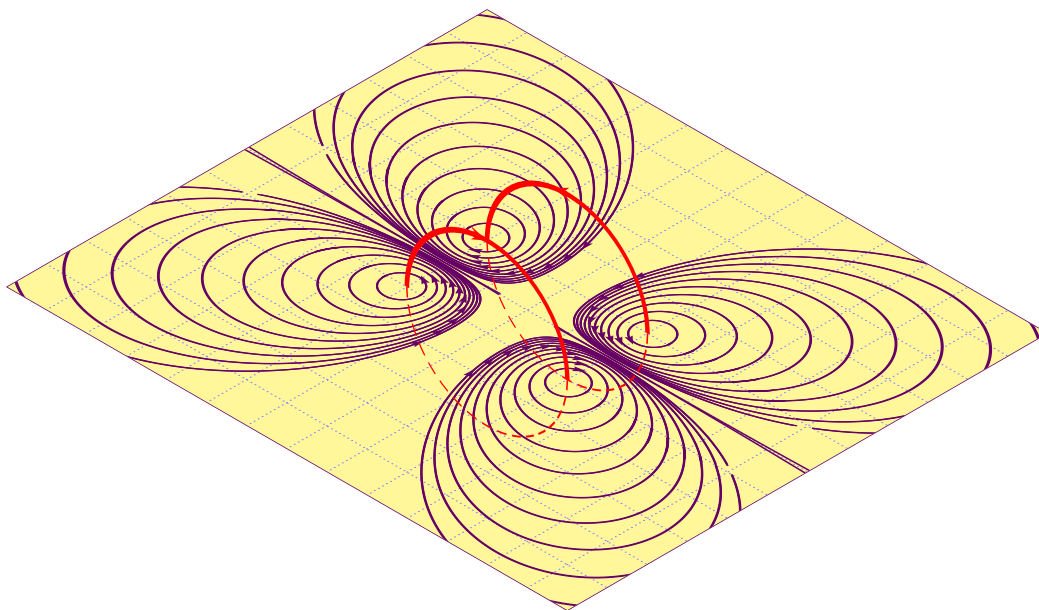

```
\psset{unit=0.75cm,AntiHelmholtz,N=2,
R=2,pointsB=500,pointsS=1000,PasB=0.02,PasS=0.00275,nS=10,
nL=2,drawSelf,styleSpire=styleSpire,styleCourant=sensCourant}
\newsstyle{grille}{subgriddiv=0,gridcolor=blue!50,griddots=10}
\newsstyle{cadre}{linecolor=yellow!50}
\begin{pspicture}(-7,-6)(7,6)
```

```
\psmagneticfieldThreeD[linecolor={HTML}{660066}](-7,-6)(7,6)
\end{pspicture}
```

7 Density plots

The optional argument `StreamDensityPlot` allows to plot the magnetic field as a colored stream density. A gray colored output is possible with setting the keyword `setgray`.

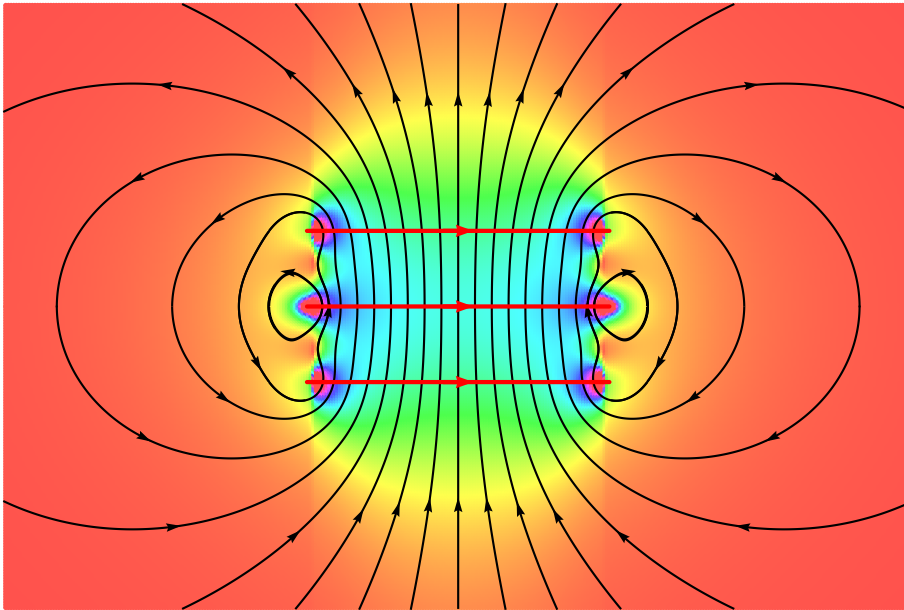

```
\begin{pspicture}(-6,-4)(6,4)
\psmagneticfield[N=3,R=2,L=2,StreamDensityPlot](-6,-4)(6,4)
\end{pspicture}
```

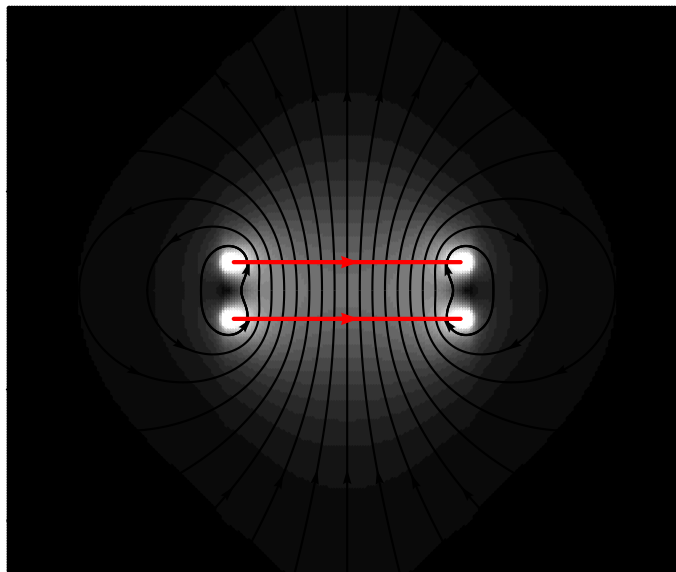

```

\psset{unit=0.75}
\begin{pspicture}(-6,-5)(6,5)
\psmagneticfield[N=2,R=2,L=1,StreamDensityPlot,setgray](-6,-5)(6,5)
\end{pspicture}

```

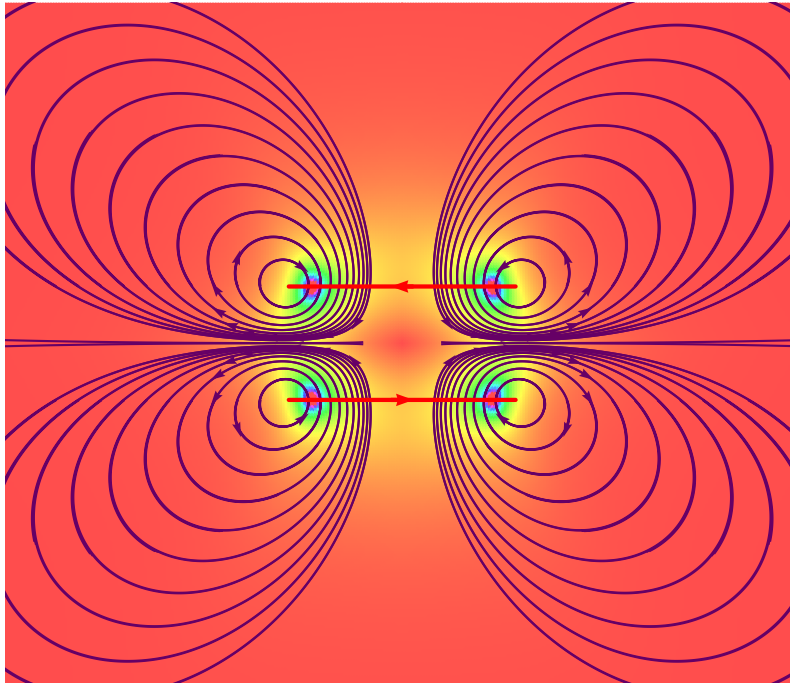

```

\psset{unit=0.75,AntiHelmholtz,
R=2,pointsB=500,pointsS=2000,PasB=0.02,PasS=0.00275,nS=10,
nL=2,drawSelf=true,styleSpire=styleSpire,styleCourant=sensCourant}
\begin{pspicture*}(-7,-6)(7,6)
\psmagneticfield[linecolor={{HTML}{660066}},StreamDensityPlot](-7,-6)(7,6)
\end{pspicture*}

```

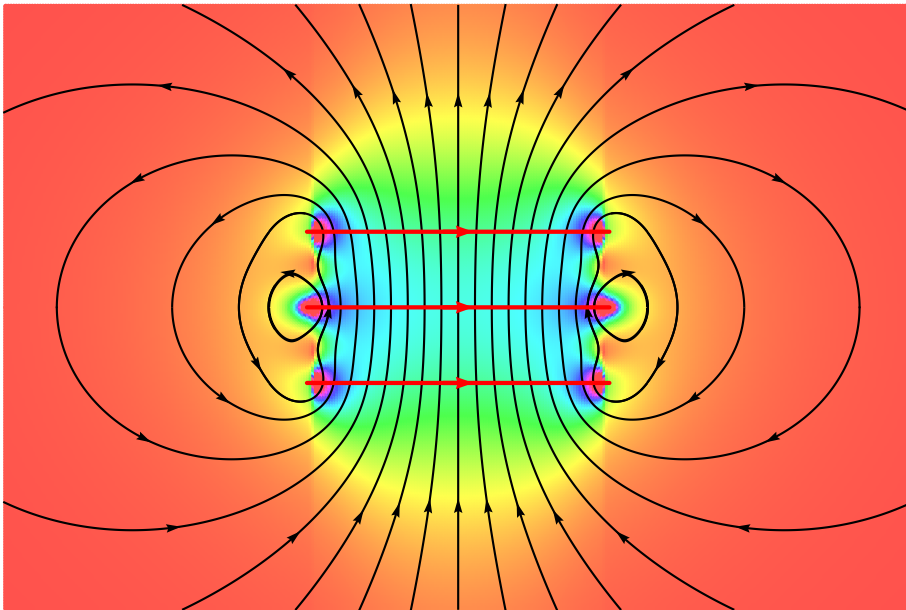

8 Stream density

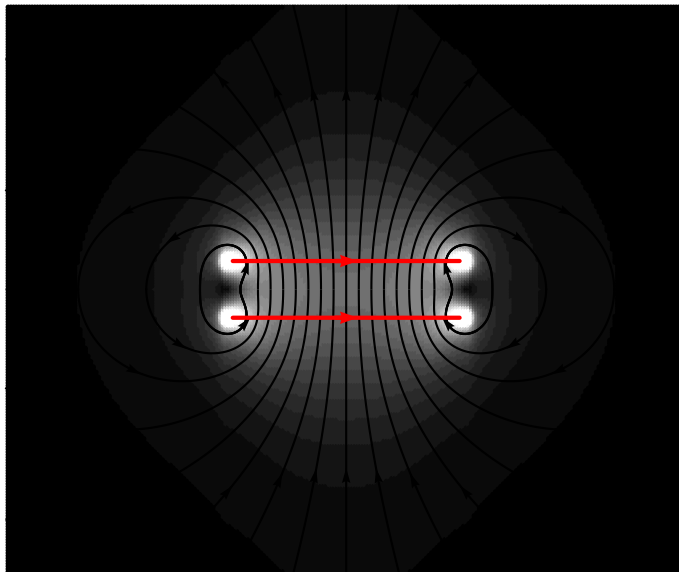

```
\begin{pspicture}(-6, -4) (6, 4)
\psmagneticfield [N=3,R=2,L=2,StreamDensityPlot](-6, -4) (6, 4)
\end{pspicture}
```

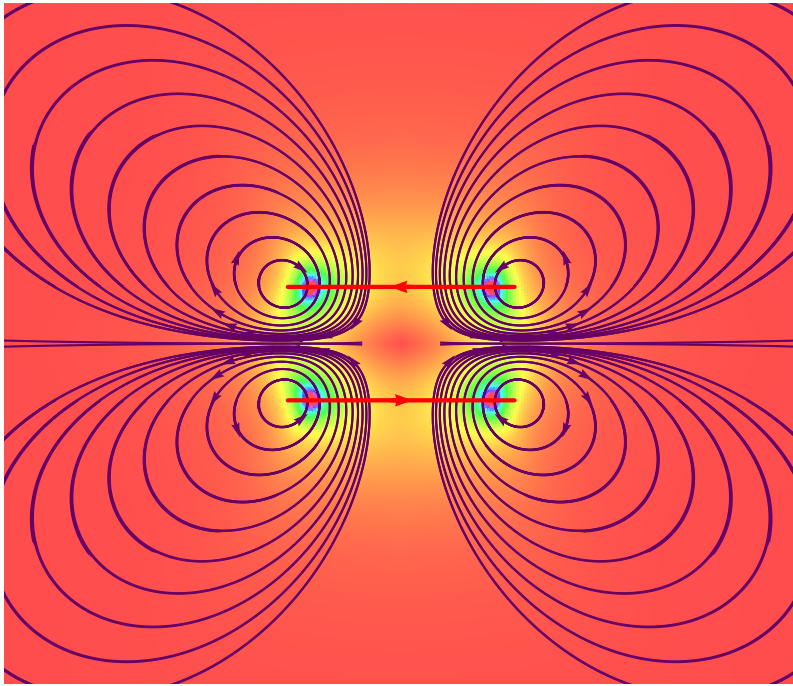

```
\psset{unit=0.75}
\begin{pspicture}(-6, -5) (6, 5)
\psmagneticfield [N=2,R=2,L=1,StreamDensityPlot,setgray](-6, -5) (6, 5)
\end{pspicture}
```



```
\psset{unit=0.75,AntiHelmholtz,
  R=2,pointsB=500,pointsS=2000,PasB=0.02,PasS=0.00275,nS=10,
  nL=2,drawSelf=true,styleSpire=styleSpire,styleCourant=sensCourant}
\begin{pspicture*}(-7,-6)(7,6)
\psmagneticfield[linecolor={HTML}{660066}],StreamDensityPlot](-7,-6)(7,6)
\end{pspicture*}
```

9 Bar magnet

The magnetic field of a bar magnet can be simulated. There is one macro for the bar magnet, which will be put over one of the above created magnetic fields.

```
\psBarMagnet [Options] [(x,y)]
```

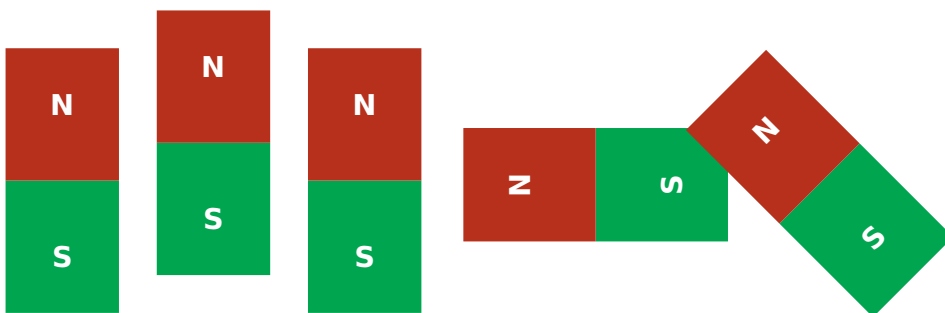

```
\begin{pspicture}(-1,-2)(12,2)
\psBarMagnet% (0,0) is assumed
\psBarMagnet(2,0.5)
\psBarMagnet*(4,0)
\psBarMagnet[rot=90](7,0)
\psBarMagnet[rot=45](10,0)
\end{pspicture}
```

Bar magnet and field can be put of the other by single commands:

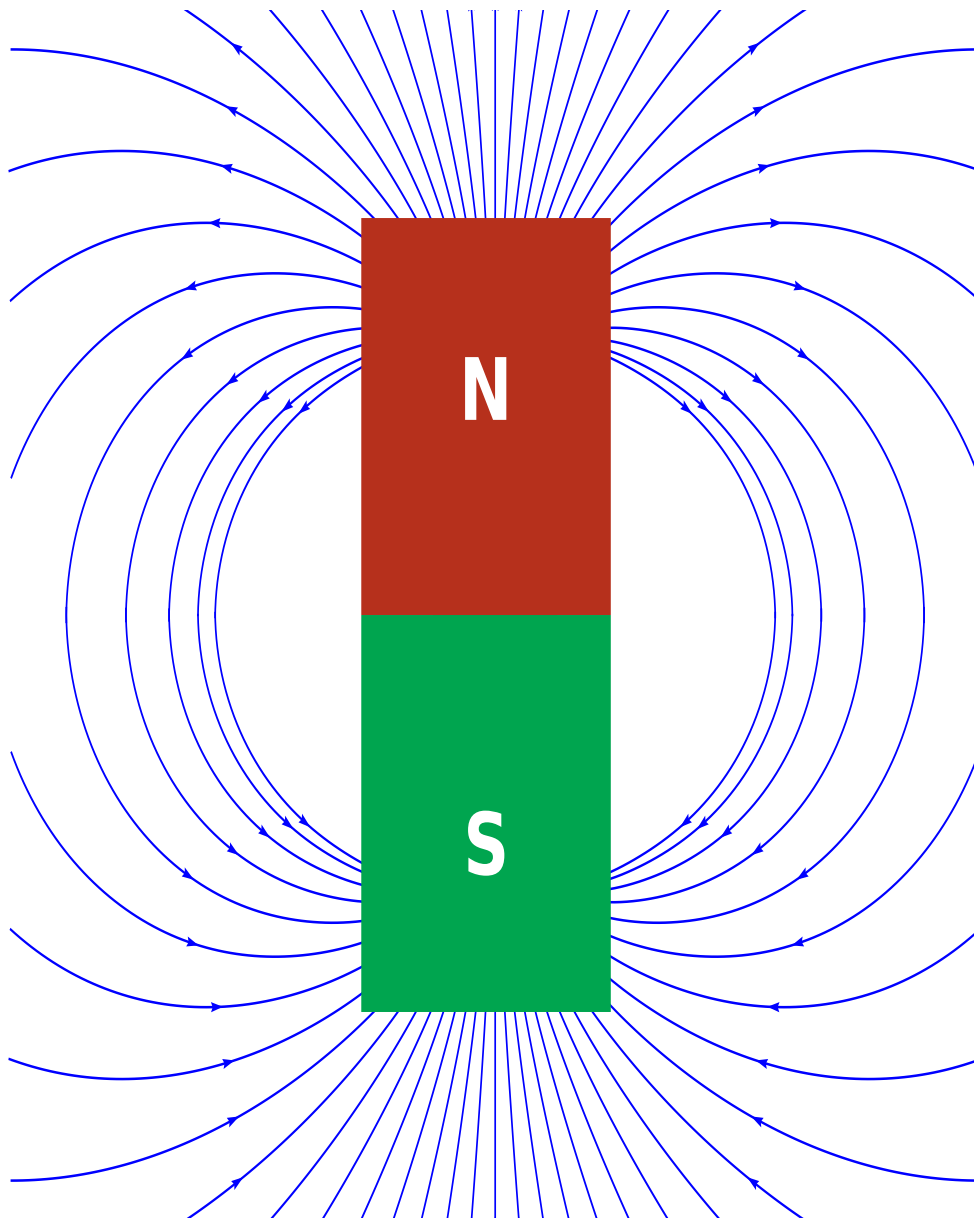

```

\begin{pspicture*}[showgrid=false](-7,-8)(7,8)
\psset{linecolor=blue}
\psscalebox{0.8 1.2}{\psmagneticfield[R=1,L=5,N=5,pointsS=200,nL=18,nS=0,PasB=0.1,
numSpires=0](-8,-10)(8,10)}
\rput(0,0){\psscalebox{2.2 3.0}{\psBarMagnet}}
\end{pspicture*}

```

or by using the optional argument `showField`:

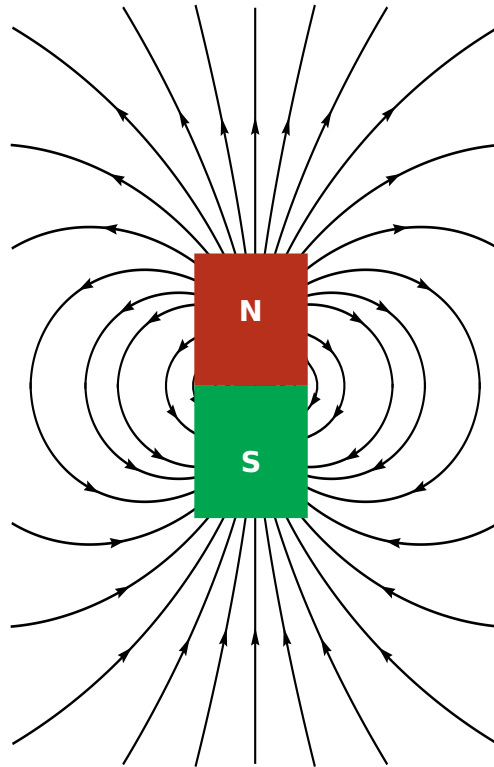

```
\begin{pspicture*}(-7,-8)(7,8)  
\psBarMagnet[showField](0,0)  
\end{pspicture*}
```

A rotation has to be done with the command `\rotatebox` from package `graphicx`:

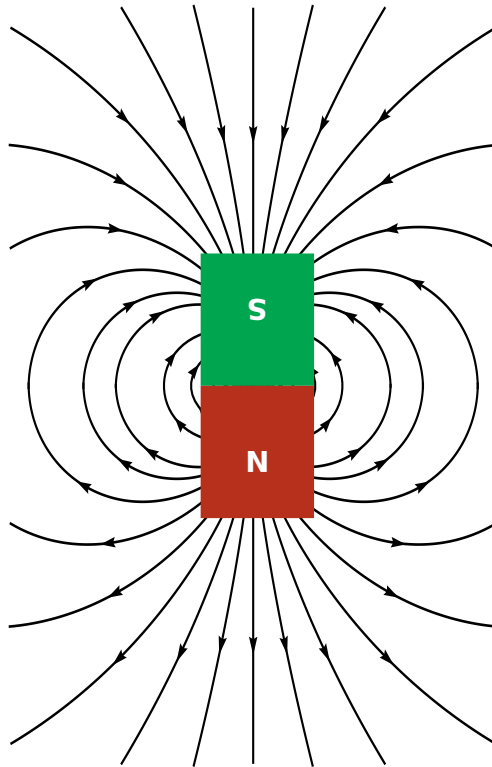

```
\begin{pspicture*}(-7,-8)(7,8)
\rotatebox{180}{\psBarMagnet[showField](0,0)}
\end{pspicture*}
```

Scaling is possible with the optional argument `magnetscale` and all options which are valid for

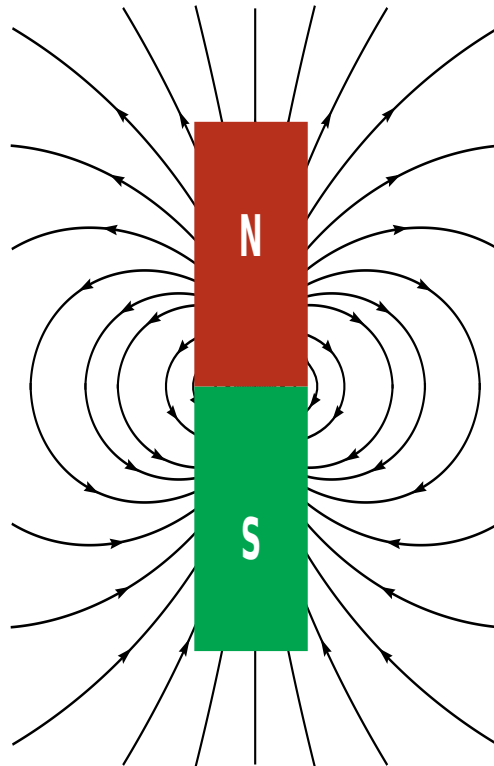

```
\begin{pspicture*}(-7,-8)(7,8)
\psBarMagnet[showField,magnetScale=1 2](0,0)
\end{pspicture*}
```

10 List of all optional arguments for `pst-magneticfield`

Key	Type	Default
R	ordinary	1
N	ordinary	6
L	ordinary	4
nL	ordinary	8
numSpires	ordinary	
pointsB	ordinary	500
pointsS	ordinary	1000
PasB	ordinary	0.02
PasS	ordinary	0.00275
nS	ordinary	1
styleSpire	ordinary	styleSpire
styleCourant	ordinary	sensCourant
drawSelf	boolean	true
AntiHelmholtz	boolean	true
StreamDensityPlot	boolean	true
setgray	boolean	true
changeNS	boolean	true
showField	boolean	true
showPoleLabels	boolean	true
fontstyle	ordinary	\large \bfseries \sffamily
magnetScale	ordinary	1 1

References

- [1] M. Abramowitz and I. A. Stegun. *Handbook of Mathematical Functions with Formulas, Graphs, and Mathematical Tables*. Corrections appeared in later printings up to the 10th Printing. Washington, D.C., USA: National Bureau of Standards Applied Mathematics Series, U.S. Government Printing Office, 1964.
- [2] Thomas J. Dolan. *Fusion Research, Volume III "Technology"*. Chapter 20 "Water-cooled magnets" , pages 600 ff "circular loops" – Integrating the Biot-Savart Law (in cylindrical geometry). Pergamon Press, 1982.
- [3] Denis Girou. "Présentation de PSTricks". In: *Cahier GUTenberg* 16 (Apr. 1994), pp. 21–70.
- [4] Michel Goosens et al. *The L^AT_EX Graphics Companion*. 2nd ed. Berlin and Heidelberg: Lehmanns Media, 2022.
- [5] Nikolai G. Kollock. *PostScript richtig eingesetzt: vom Konzept zum praktischen Einsatz*. Vaterstetten: IWT, 1989.
- [6] Herbert Voß. *PSTricks – Grafik für T_EX und L^AT_EX*. 7th ed. Heidelberg and Berlin: DANTE – Lehmanns Media, 2019.
- [7] Timothy Van Zandt. *multido.tex - a loop macro, that supports fixed-point addition*. [CTAN:/graphics/pstricks/generic/multido.tex](https://ctan.org/graphics/pstricks/generic/multido.tex), 1997.

- [8] Timothy Van Zandt and Denis Girou. “Inside PSTricks”. In: *TUGboat* 15 (Sept. 1994), pp. 239–246.

Index

D

drawSelf, 4

G

graphicx, 21

K

Keyword

- drawSelf, 4
- L, 2
- linecolor, 4
- linewidth, 4
- magnetscale, 22
- N, 2
- nL, 4, 8
- nS, 4, 8
- numSpires, 4, 8
- PasB, 4
- PasS, 4
- pointsB, 4
- pointsS, 4
- R, 2
- setgray, 15
- showField, 20
- StreamDensityPlot, 15
- styleCourant, 4
- styleSpire, 4
- viewpoint, 13

L

L, 2

linecolor, 4

linewidth, 4

M

Macro

- \psBarMagnet, 18
 - \psframe, 13
 - \psmagneticfield, 4, 13
 - \psmagneticfieldThreeD, 4, 13
 - \rotatebox, 21
- magnetscale, 22

N

N, 2

nL, 4, 8

nS, 4, 8

numSpires, 4, 8

P

Package

- graphicx, 21
 - pst-3d, 13
 - pst-magneticfield, 2
 - pstricks, 4
- PasB, 4
- PasS, 4
- pointsB, 4
- pointsS, 4
- \psBarMagnet, 18
- \psframe, 13
- \psmagneticfield, 4, 13
- \psmagneticfieldThreeD, 4, 13
- pst-3d, 13
- pst-magneticfield, 2
- pstricks, 4

R

R, 2

\rotatebox, 21

S

sensCourant, 4

setgray, 15

showField, 20

StreamDensityPlot, 15

styleCourant, 4

styleSpire, 4

V

Value

- sensCourant, 4
 - styleSpire, 4
- viewpoint, 13